

APPENDIXI- SPECIFICATION

- 1.Varies with user weight,terrain type, battery amp-hour(Ah),battery charge , Battery condition, tire type. and tire condition, This specification can be subject to a variance of (+ or -) 10%
 - 2.Due to manufacturing tolerances and continual product improvement,this specification can be subject to a variance of (+ or -) 3%
 - 3.Approximate overall inflated dimensions.
 - 4.
 - 5.Tested in accordance with ASN/RESNA,WC Vol 2,Section 4& ISO 7176-4 standards. Results derived from theoretical calculation based on battery specifications and drive system performance. Test conducted at maximum weight capacity.
- NOTE:This product conforms to all applicable ANSL-RESNA testing requirements and ISO 7176 EN12184 Standards .All specifications subject to change without notice.

Blimo X-40 operating instructions



CONTENTS

I. INTRODUCTION.....	1
II. SAFETY	2
III. YOUR TRAVEL SCOOTER	17
IV. BATTERIES AND CHARGING.....	23
V. OPERATION.....	30
VI. COMFORT ADJUSTMENTS.....	33
VII. DISASSEMBLY AND ASSEMBLY.....	35
VIII. BASIC TROUBLESHOOTING.....	36
IX. CARE AND MAINTENANCE.....	38
X. WARRATY.....	42
APPENDIXI-SPECIFICATIONS.....	28

SAFETY GUIDELINES

Dear users,thank you for using our mobility scooter ,we hope it can bring convenience for your work and life.In order to correctly use and operate the product ,keep it in good condition,prolong its service life,please read the instructions carefully before using the product



WARNING!And authorized provider or qualified technician must perform the initial setup of this scooter and must perform all of the procedures in this manual.The symbols below are used throughout this owner’s manual and on the scooter to indentify warnings and important information.It is very importfor you to read them and understand them completely.



WARNING!Indicates a potentially hazardous condition.Failure to follow designated procedures can cause either personal injury ,component damage, Or malfunction.On the product,this icon is represented as left figure.

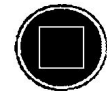

MANDATORY!These actions should be performed as specified.Failure to perform mandatory actions can cause personal injury and /or equipment On the product,this icon is represented as left figure.

Please fill out the following information for quick reference:

Provider:	
Address:	
Phone Number	
Purchas Date:	Serial Number:

NOTE:This Owner’s manual is compiled from the latest specifications and product information available at the time of publication .We reserve the right to make changes as they become necessary.Any changes to our product you have purchased.The latest/current Version of this manual is available on our website.

I. INTRODUCTION

SAFETY

The product you have purchased combines state-of-the-art components with safety, comfort, and styling in mind. We are confident the design features will provide you with the conveniences you expect during your daily activities. Understanding how to safely operate and care for this product should bring your years of trouble free operations and service.

Read and follow all instructions, warnings, and notes in this manual and all other accompanying literature before attempting to operate this product for the first time. In addition, Your safety depends upon you, as well as your provider, caretaker, healthcare professional in using good judgment.

If there is any information in this manual which you do not understand, or if you require Additional assistance for set up or operation, please contact your Authorized provider. Failure to follow the instructions, warnings, and notes in this manual and those Located on your product can result in personal injury or product damage and will void our product warranty.

PURCHASER'S AGREEMENT

By accepting delivery of this product, you promise that you will not change, alter, or Modify this product or remove or render inoperable or unsafe any guards, shields, or other safety features of this product; fail, refuse or neglect to install any retrofit kits from time to time provided by us to enhance to preserve the safe use of this product.

SHIPPING AND DELIVERY

Before using your scooter, make sure your delivery is complete as some components may be individually packaged. If you do not receive a complete delivery, please contact your authorized provider immediately. Where damage has occurred during transport, either to the packaging or content, please contact the delivery company responsible.

II. SAFETY

PRODUCT SAFETY SYMBOLS

The symbols below are used on the travel scooter to identify warnings, Mandatory actions and prohibited actions. It is very important for you to read and Understand them completely.



Read and follow the information in the owner's manual.



Maximum seating weight



Pinch/Crush points created during assembly



Corrosive chemicals contained in battery



EMI/RFI-This product has been tested and passed at the an immunity level of 20V/M



**Unlocked and in freewheel mode. Place unit on level ground and to one side when changing from drive mode to freewheel mode or freewheel mode to drive mode.
Locked and in drive mode**



Use only AGM or Gel-Cell batteries to reduce the risk of leakage or explosive conditions

II.SAFETY



Do not allow unsupervised children to play near the Travel Scooter while the batteries are charging



Do not remove anti-tip wheels.



Do not use a cell phone, walkie/talkie, laptop or other radio transmitter while operation



Avoid exposure to rain, snow, ice, salt or standing water whenever possible. Maintain and store in a clean and dry condition



Removal of grounding prong can create electrical hazard
If necessary, properly install an approved 3-pronged adapter to an electrical outlet having 2-pronged plug access.



Do not connect an extension cord to the AC/DC converter or the battery charger.



Keep tools and other metal objects away from battery terminals. Contact with tools can cause electrical shock.



Do not open the battery pack until you have read the instructions within the Owner's manual on how to do so.



Keep your hands away from the tires when driving. Be aware that loose fitting clothing can become caught in the drive tires.

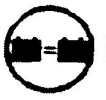

Do not use batteries with different amp-hour (Ah) capacities. Do not Mix old and new batteries. Always replace both batteries at the same time

II.SAFETY



Do not sit on the mobility product when it is being used in connection with any type of lift /elevation product.



When on any sort of an incline or decline, never place the travel scooter in free wheel mode while seated on it or standing next to it



Explosive conditions exist!



Disposal and recycling-contact your authorized Provider for information on proper disposal of your product and its packaging.



Waste and packaging process



Wear safety goggles



Battery charger for indoor



Contains lead



Flammable material. Do not expose to open

GENERAL



MANDATORY! Do not operate your new Travel Scooter for the first time without completely reading and understanding this owner's manual

Your Travel Scooter is a state-of-the-art life-enhancement device designed to increase mobility. We provide an extensive variety of products to best fit the individual needs of the Travel Scooter user. Please be aware that the final

II.SAFETY

selection and purchasing decision regarding the type of Travel Scooter to be used is the responsibility of the Travel Scooter user who is capable of making such a Decision and his /her healthcare professional(i.e.,medical doctor ,physical therapist,etc)

The contents of this manual are based on the expectation that a mobility device expert has properly fitted the Travel Scooter to the user and has assisted the prescribing healthcare professional and /or the authorized Provider in the instructions process for the use of the product.

There are certain situations,including some medical conditions ,where the Travel Scooter user will need to practice operating the Travel Scooter in The presence of a trained attendant.A trained attendant can be defined as a family member or care Professional specially trained in assisting a Travel Scooter user in various daily Living activities.

As you begin using your Travel Scooter during daily activities,you will probably Encounter situations in which you will need some practice .Simply take your time And you will soon be in full and confident control as you maneuver through door-ways,on and off lifts ,up and down ramps and over moderate terrain.

Below are some precautions ,tips and other safety considerations that will help you become accustomed to operating the Travel Scooter safely.

MODIFICATIONS

our scooter has designed and engineered your Travel Scooter to provide maximum mobility and utility.However,under no circumstances should you modify, Add,remove or disable any feature,part or function of your Travel Scooter.



WARNING!Do not modify your Travel Scooter in any way not authorized by us.Do not use accessories if they have not been

tested of approved for our products REMOVABLE PARTS



WARNING!Do not attempt to lift or move your Travel Scooter by any of its removable parts ,including the armrests,seat or shroud

PRE-RIDE SAFETY CHECK

Get to know the feel of your Travel Scooter and its capabilities.We recommends

II.SAFETY

that you perform a safety check before each use of make sure your Travel Scooter Operates smoothly and safely.

Perform the following inspections prior to using your scooter:

- Check all electrical connections.Make sure they are tight and not corroded
- Check all harness connections.Make sure they are secured properly.
- Check the brakes.
- Check battery charge.

If you discover a problem,contact your authorized provider for assistance.

WEIGHT LIMITATIONS

Your scooter is rated for a maximum weight capacity.Refer to the specifications Table for information.



MANDATORY!Stay within the specified weight capacity for your scooter .Exceeding the weight capacity voids your warranty .We

will not be held responsible for injuries and /or property damage resulting from failure to observe Weight limitations.



WARNING!Do not carry passengers on your scooter .

Carring passengers on your scooter may affect the center of gravity,resulting in a tip or a fall.

INCLINE INFORMATION

More and more building have ramps with specified degrees of inclination,designed for easy and safe access. Some ramps may have turning switchbacks (180-Degree turns) that require you to have good cornering skills on your scooter.

■ Proceed with extreme caution as you approach the downgrade era ramp or other incline

■Take wide swings with your scooter around any tight corners.If you do that ,the scooter's rear wheels will follow a wide arc,not cut the corner short,and not bump into or get hung Up on any railing corners.

■ When driving down a ramp,keep the scooter's speed adjustment set to the slowest speed setting to ensure a safely controlled descent.

■ Avoid sudden stops and starts.When climbing in incline,try to keep your Travel Scooter moving,If you must stop,start up Again slowly,and then accelerate

II.SAFETY

cautiously. When driving down an incline, do so by setting the speed adjustment dial to the slowest setting and driving in the forward direction only. If your Travel Scooter starts to move down the incline faster than you anticipated or desired, allow it to come to a complete stop by releasing the throttle control lever. Then push the Throttle control lever forward slightly to ensure a safely controlled descent.

Starts to move down the incline faster than you anticipated or desired, allow it to come to a complete stop by releasing the throttle control lever. Then push the Throttle control lever forward slightly to ensure a safely controlled descent.



WARNING! When on any sort of an incline or decline, never place the Travel Scooter in freewheel mode while seated on

it or standing next to it.

WARNING! When climbing an incline, do not zigzag or drive at an angle up the face of the incline. Drive your Travel Scooter straight up the incline. This greatly reduces the possibility of a tip or a fall. Always exercise extreme caution when negotiating an incline.



WARNING! Do not drive your Travel Scooter across the side of an incline or diagonally up or down an incline; do not stop, if possible,

While driving up or down an incline.

WARNING! You should not travel up or down a potentially hazardous incline (i.e., areas covered with snow, ice, cut grass, or wet leaves).

WARNING! Even though your Travel Scooter is capable of climbing slopes greater than those illustrated in Figure 1 do not, under any circumstances, exceed the incline guidelines or any other specifications presented in this manual. Doing so could cause instability in your Travel Scooter.

Handicap public access ramps are not subject to government regulation in all countries, and therefore do not necessarily share the same standard percent of slope. Other inclines may be natural or, if man-made, not designed specifically for Travel Scooters. Figure 1 illustrates your Travel Scooter's stability and its ability to climb grades under various weight loads and under controlled testing conditions. These tests were conducted with the Travel Scooter's seat in the highest position and adjusted rearward on the seat base to its farthest rearward position. Use this information as a guideline. Your Travel Scooter's ability to travel up inclines is

II.SAFETY

affected by your weight, your Travel Scooter's speed, your Travel Scooter's speed, your angle of approach to the incline, and your Travel Scooter setup.

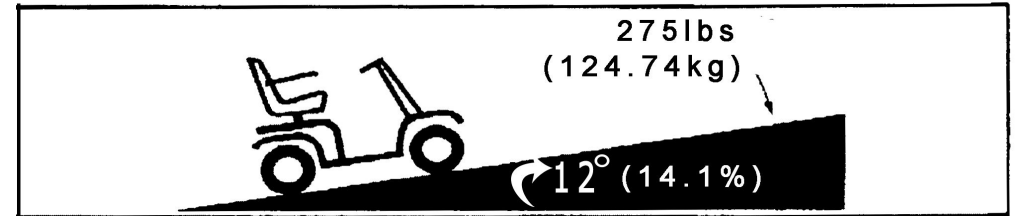

Figure 1. Maximum Recommended Incline Angel



WARNING! Any attempt to climb or descend a slope steeper than what is shown in figure 1 may put your Travel Scooter in an unstable position and cause it to tip. **WARNING!** Never carry an oxygen tank weighing than 15 lbs (6.8 kg). Never fill the front or rear basket with contents exceeding 15 lbs (6.8 kg).

When you approach an incline, it is best to lean forward. See figures 2 and 2A. This shifts the center of gravity of you and your Travel Scooter toward the front of the Travel Scooter for improved stability.

NOTE: When negotiating ramps, if the throttle control lever is released while moving forward, the powered Travel Scooter may "rollback" approximately 1 foot (30.5 cm) before the brake engages. If the throttle control lever is released while moving in reverse, the powered Travel Scooter may "rollback" approximately 3 feet (one meter) before the brake engages.

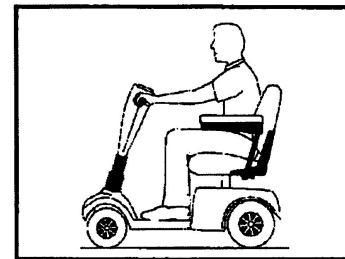

Figure 2. Normal Driving Position

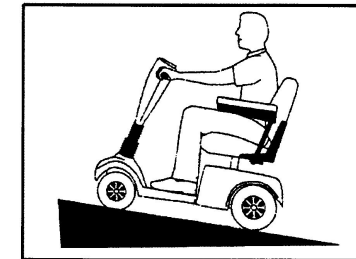

Figure 2A. Increased stability Driving position

II.SAFETY

CORNERING INFORMATION

Excessively high cornering speeds can create the possibility of tipping. Factors which affect the Possibility of tipping include, but are not limited to ,cornering speed,steering angle(how sharply you are turning uneven road surfaces,inclined road surfaces ,riding from an area of low traction To an area of high traction (such as passing from a grassy area to a paved area- especially at high speed while turning), and directional changes.High cornering speeds are not recommended ,If you feel that you may tip over in a corner, reduce your speed and steering angle (i.e., Lessen the sharpness of the turn) to prevent your Travel Scooter from tipping .



WARNING!When cornering sharply,reduce your speed and maintain a stable center of gravity.when using your Travel Scooter at Higher speeds,do not corner sharply .This greatly reduces the possibility of a tip or fall .Always exercise common sense when cornering.

BRAKING INFORMATION

Your Travel Scooter is equipped with these powerful brake systems:

- Regenerative: Uses electricity to rapidly slow the vehicle when the throttle control lever returns to the centre/stop position.
- Disc Park Brake:Activates mechanically after regenerative braking slows the vehicle to near stop,or when power is removed from the system for any reason.

OUTDOOR DRIVING SURFACES

Your Travel Scooter is designed to provide optimum stability under normal driving Condition-dry,level surfaces composed of concrete,blacktop,or asphalt,However, We recognize that there will be times when you will encounter other surface types .For this reason,your Travel Scooter is designed to perform admirably on packed soil ,grass,gravel,Feel free to use your Travel Scooter safely on lawns and in park areas.

- Reduce your Travel Scooter's speed when driving on uneven terrain and / or soft Surfaces.
- Avoid tall grass that can become tangled in the running gear.
- Avoid loosely packed gravel and sand.
- If you feel unsure about a driving surface ,avoid that surface.

II.SAFETY

PUBLIC STREETS AND ROADWAYS



WARNING!You should not operate your Travel Scooter on public Streets and roadways

to see you when you are seated on your Travel Scooter. Obey all local pedestrian traffic rules. Wait until your path is clear to traffic,and then proceed with extreme caution.

STATIONARY OBSTACLES(STEPS,CURBS ,ETS.)



WARNING!Do not drive near raised surfaces,unprotected ledges, And/or drop-offs (curbs,porches,stairs,etc.)

WARNING! Do not attempt to have your Travel Scooter climb or descend an Obstacle that is inordinately high.

WARNING! Do not attempt to have your Travel Scooter proceed backward down an step ,curb,or other obstacle. This may cause the Travel Scooter to tip

WARNING! Be sure your Travel Scooter is traveling perpendicular to any curb you may be required to ascend or descend see figures 3 and 4.

WARNING! Do not attempt to negotiate a curb that has a height greater than 2 In (5cm)

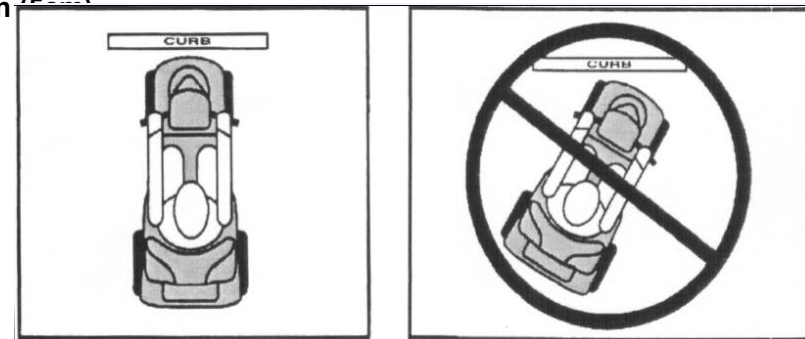

Figure3. Correct Curb Approach Figure 4. Incorrect Curb Approach

INCLEMENT WEATHER PRECAUTIONS

Exposure of your Travel Scooter to inclement weather conditions should be

II.SAFETY

avoided whenever possible.If suddenly caught up in rain,snow ,severe cold or heat while operating your Travel Scooter,proceed to shelter at the earliest opportunity. Thoroughly dry your Travel Scooter before storing,charging,or operating your Travel Scooter.



PROHIBITED!Operating in rain,snow,salt ,mist/spray conditions , and on icy slippery surfaces can have an adverse affect on the

electrical system.Maintain and store your Travel Scooter in a dry and clean condition.



WARNING! Prolonged exposure to hot or cold conditions may affect the temperature of upholstered and non-upholstered items

On the Travel Scooter,possibly resulting in skin irritation.Exercise caution when using your Travel Scooter in extremely hot or cold conditions or when Exposing your Travel Scooter to direct sunlight for prolonged periods of time .

FREEWHEEL MODE

Your Travel Scooter is equipped with a manual freewheel lever that ,when pushed forward,allows the Travel Scooter to be pushed.For more information about how to Place your Travel Scooter into and out of freewheel mode ,see III “Your Travel scooter”.



WARNING!When your Travel Scooter is in freewheel mode,the braking system is disengaged.

- **Disengage the drive motors only on a level surface.**
- **Ensure t he key is removed frm the key switch.**
- **Stand beside the Travel Scooter to engage or disengage freewheel mode. never sit on a Travel Scooter to do this.**
- **After you finished pushing your Travle Scooter,always return it to the drive mode to lock the brakes.**

An added feature built into the Travle Scooter is “push-too-fast” protection which Safeguards the Travel Scooter against gaining excessive speed while in freewheel mode.

II.SAFETY

“push-too-fast” operates differently depending on which of two condtions exists:

■ If the key is switched “off “while in freewheel mode,the Travel Scooter’s controller activates regenerative braking when the Travel Scooter is pushed faster than a maximum threshod which has been preprogrammed.In this case ,the controller is acting as a speed governor.

■ If the key is switched “on” while in freewheel mode,you will encounter considerable resistance at any speed .This prevents the Travel Scooter from gaining unwanted momentum should the manual free wheel lever inadvertently be released while driving the Travel Scooter.

STAIRS AND ESCALATORS

Travel Scooter are not designed to travel up or down stairs or escalators.Always use that by an elevator.



WARING! Do not use your Travel Scooter to negotiate steps or escalators.

DOORS

- Determine if the door opens toward or away from you .
- Use your hand to turn the knob or push the handle or push-bar.
- Drive your Travel Scooter gently and slowly forward to push the door open.Or Drive your Travel Scooter gently and slowly rearwards to pull the door open.

Elevators

Modem elevators have a door edge safety mechanism that,when pushed ,reopens the door(s).

■ If you are in the doorway of an elevator when the door(s) begin to close ,push on the rubber door edge or allow the rubber door edge to contact the Travel Scooter and the door will reopen.

■ Use care that pocketbooks,packages,or Travel Scooter accessories do not Become caught in elevator doors.

NOTE:If your Travel Scooter’s turning radius is greater than 60 in.(1500 ram) it may be difficult to maneuver in elevators and building entrances.Use cau-

II.SAFETY

tion when attempting to turn or maneuver your Travel Scooter in small spaces,and avoid areas that might pose a problem.

LIFT/ELEVATION PRODUCTS

If you will be traveling with your Travel Scooter,you may find it necessary to use a Lift/elevation product to aid in transportation.we scooter recommends that ou closely review the instructions,specifications,and safety information set forth by the manufacture of the lift /elevation product before using that product.



WARNING!Never sit on your Travel Scooter when it is being used in connection withany type of lift/elevation

product. Your Travel Scooter was not designed with such use in mind and any injury incurred from such use is not be responsibility of us.

BATTERIES

In addition to following the warning below, be sure comply with all other battery handling information.



MANDATORY!Battery posts, terminals,and related accessor -ies contain lead and leadcompounds.Wear goggles and

Wash hands after handing.



WARNING!Scooter batteries are heavy.See specifications table.If you are unable to lift that much weight.be sure to get help,Use

proper lifting techniques and avoid lifting beyond your capatyi.

WARNING!Always protect the batteries from freezing and never charge a frozen battery,

WARNING!Connect the battery harnesses in the proper manner.RED(+) cables must be connected to positive(+) battery terminals/posts.**BLACK(-)** cables must be connected to negative(-)battery ternimals/ posts .**REPLACE Cables immediately if damaged. Protective caps must be installed over all Battery terminals.**

NOTE:If you encouter a damaged or cracked battery,immediately enclose it in a

II.SAFETY

Plastic bag and contact your local waste disposal agency or authorized provider for instructions on disposal and battery recycling.which is our recommended course of action.

MOTOR VEHICLE TRANSPORT

We recommends that you do not remain seated in your Travel Scooter while traveling in a motor vehicle .The Travel Scooter should be stowed in the trunk of a car or in the back of truck or van with the batteries removed and properly secured In addition,all removable Travle Scooter parts,including the armrests ,seat and shroud should be removed and/or properly secured during motor vehicle transport



WARNING!Although your Travel Scooter may be equipped with a positioning belt.this belt is not designed to provide.Restrictant

during motor vehicle transport.Anyone travelling in a motor vehicle should be properly secured in the motor vehicle seat with safety belts fastened securely.

WARNING!Do not sit on your Travel Scooter while it is in a moving vehicle.

WARING!Always be sure your Travel Scooter and its batteries are properly Secured when it is bing transported.Batteries should be secured in an upright position,and protective caps should be installed on the battery terminals,Batteries should not be transported with any flammable or combustibile items.

POSITIONING BELTS

Although your Travel Scooter may be equipped with a positioning belt,this belt is not designed to provide proper restraint during motor vehicle transport.Anyone traveling in a motor vehicle should be properly secured in the motor vehicle seat with safety belts fastened securely.



WARNING!Do not sit on your Travel Scooter while it is in a moving vehicle.

WARNING!Ensure your travel scooter and its batteries are properly secured When being transported

PREVENTING UNINTENDED MOVEMENT.

II.SAFETY



WARNING!If you anticipate being seated in a stationary position for an extended period of time,turn off the power.This will prevent

unexpected motion from inadvertent throttle control lever contact.

GETTING ONTO AND OFF OF YOUR TRAVEL SCOOTER

Getting onto and off of your Travel Scooter requires a good sense of balance.

Please observe the following safety tips when getting onto and off of your Travel scooter:

- Remove the key from the key switch.
- Ensure that your Travel Scooter is not in freewheel mode .See III."Your Travel Scooter."
- Ensure that the seat is secured into place .
- Pivot the armrests up to make getting onto and off of the Travel Scooter easier.



WARNING!Position yourself as far back as possible in the Travel Scooter seat to prevent the Travel Scooter from tipping and

causing injury.

WARNING!Avoid putting all of your weight on the Travel Scooter armrests And do not use the armrests for weight bearing purposes,such as transfers. such use may cause the Travel Scooter to tip,resulting in a fall from the Travel Scooter and/or personal injury.

WARNING!Avoid putting all of your weight on the floorboard.Such use may cause the Travel Scooter to tip.

REACHING AND BENDING

Avoid reaching or bending while driving your Travel Scooter.Bending forward creates the risk of accidental throttle control lever contact .

Bending to the side while seated creates the risk of tipping .It is important to maintain a stable centre of gravity and keep the Travel Scooter from tipping .We recommends that the Travel Scooter user determine his/her personal limitations and practice bending and reaching in the presence of a qualified attendant.

II.SAFETY



WARNING!Do not bend,lean,or reach for objects if you have to pick them up from the Travel Scooter deck or from either side of

the Travel Scooter.Movements such as these may change your center of gravity and the weight distribution of the Travel Scooter and cause your

Travel Scooter to tip,



PROHIBITEND!Keep your hands away from the tires when driving when driving.Be aware that loose fitting clothing can become

caught in drive tires.

PRESCRIPTION DRUGS/PHYSICAL LIMITATIONS

The Travel Scooter user must exercise care and common sense when Operating his/her Travel Scooter.This includes awareness of safety issues when taking prescribed or over-the-counter drugs or when the user has specific physical limitations.

ELECTROMAGNETIC AND RADIO FREQUENCY INTERFERENCE (EMI/RFI)



WARNING!Laboratory tests have shown that electromagnetic and radio frequency waves can have an adverse affect on the perfor-

mance of electrically-powered mobility vehicles.

Electromagnetic and Radio Frequency Interference can come from sources such as cellular phones,mobile two-way radios(such as walkie-talkies),radio stations,TV stations,TV stations amateur radio (HAM) transmitters,wireless computer links,microwave signals ,paging transmitters and medium-range mobile transceivers used by emergency vehicles.In some cases,these waves can cause unintended movement or damage to the control system.Every electrically-powered

Mobility vehicle has an immunity (or resistance)to EMI.The higher the immunity level,the greater the protection against EMI.This product has been tested and has passed at an immunity level of 20V/M.

II. SAFETY



WARNING! Be aware that cell phones, two-way radios, laptops, and other types of radio transmitters may cause unintended movement

of your electrically-powered mobility vehicle due to EMI. Exercise caution when using any of these items while operating your mobility vehicle and avoid coming into close proximity of radio and TV stations.



WARNING! The addition of accessories or components to the electrically-powered mobility vehicle can increase the susceptibility of

the vehicle to EMI. Do not modify your Travel Scooter in any way not authorized by us. **WARNING!** The electrically-powered mobility vehicle itself can disturb the performance of other electrical devices located nearby, such as alarm systems.

III. YOUR TRAVEL SCOOTER

TILLER CONSOLE

The tiller console houses all controls needed to drive your Travel Scooter, including the key switch, turn lamp, horn button, speed adjustment dial, drive control lever and the battery condition meter. See figure 5.

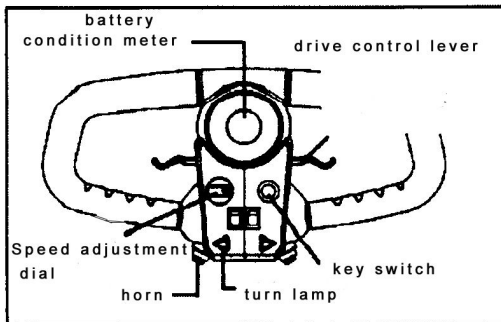

Figure 5. Tiller Console



PROHIBITED! Do not expose the tiller console to moisture. In the event that the tiller console does become exposed to moisture, do

III. YOUR TRAVEL SCOOTER

not attempt to operate your Travel Scooter until the tiller console has dried thoroughly.

Key Switch

■ Insert the key into the key switch and turn it clockwise to power up (turn on) your Travel Scooter.

■ Turn the key counterclockwise to power down (turn off) your Travel Scooter. Although the key can be left in the key switch when the Travel Scooter is powered Down, we recommend removing it to prevent unauthorized use of your Travel scooter.



WARNING! If the key is moved of the "OFF" position while your Travel Scooter is in motion, the electronic brakes will engage and

your Travel Scooter will come to an abrupt stop!

Throttle Control Lever

This lever allows you to control the forward speed and the reverse speed of your Travel Scooter up to the maximum speed you preset with the speed adjustment dial.

■ Place your right hand on the right handgrip and your left hand on the left handgrip.

■ Use your right thumb to push the right side of the lever to disengage your Travel

Scooter's brakes and move forward.

■ Release the lever and allow your Travel Scooter to come to a complete stop. Before pushing the other side of the lever to move in reverse.

■ When the throttle is completely released, it automatically returns to the center "stop" position and engages your Travel Scooter's brakes.

Horn Button

This button activates a warning horn. Your Travel Scooter must be turned on for the horn to be operational. Do not hesitate to use the warning horn when doing so may prevent accident or injury.

Speed Adjustment Dial

III. YOUR TRAVEL SCOOTER

This dial allows you to preselect and limit your Travel Scooter's top speed.

- The image of the tortoise represents the slowest speed setting .
- The image of the hare represents the fastest speed setting.

Battery Condition Meter

When the key is fully inserted into the key switch ,this meter indicates approximate Battery strength.For further information on the battery condition meter,see IV. "Batteries and Charging"

REAR SECTION

The manual freewheel lever,anti-tip wheels,and motor/transaxle assembly are located on the rear section of your Travel Scooter.See figure 6.



WARNING! Before placing your Travel Scooter into or taking it out Of freewhell mode,remove the key from the key switch.Never sit

On Travel Scooter when it is in freewheel model.Never put a Travel Scooter in freewheel mode on any incline.

Manual Freewheel Lever

Whenever you need or want to push your Travel Scooter for short distances,you Can put it in freewheelmode.

- 1.Locate the manual freewheel lever at the top right of the rear section.
- 2.Push forward on the manual freewheel lever to disable the drive system and the brake system.
- 3.You may now push your Travel Scooter.
- 4.Push the manual freewheel lever rearward to reengage ther drive and the brake Systems;this takes your Travel Scooter out of freewheel mode.

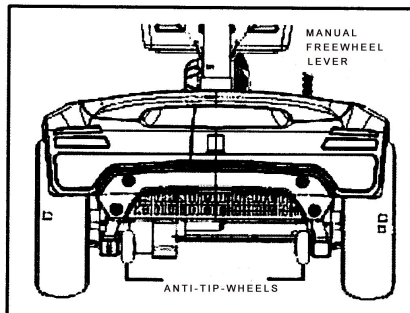

Figure 6.Rear Section

III. YOUR TRAVEL SCOOTER



WARNNG! When your Travel Scooter is in freewheel mode,the braking system is disengaged.

- Disengage the drive motors only on a level surface.
- Ensure the key is removed from the key switch
- Stand to the side of the Travel Scooter of engage of disengage freewheel mode.

Never sit on a Travel Scooter to de this.

- After you have finished pushing your Travel Scooter,always return ti to the drive Mode to lock the brakes.

Anti- Tip Wheels.

The anti-tip wheels are an integral and important safety feature of your Travel Scooter.They are bolted to the frame at the rear of the Travel Scooter.



PROHIBITED!Do not remove the anti-tip wheels or modify your Travel Scooter in any way that is not authorized by us

Motor /Transaxle Assembly

The motor/transaxle assembly is an electromechanical unit that converts electrical Energy from your Travel Scooter's batteries into the controlled mechanical egergy that drives the Travel Scooter's wheels.

BATTERY PACK

Your Travel Scooter is equipped with an innovative,easy to remove battery pack. A handle on the top of the battery pack makes it easy to lift the pack off of the Travel Scooter with one hand.The battery pack contians two batteries (standard 20 Ah),the charger power cord receptacle,the main circuit breaker(reset button), and the battery pack fuse.See figure 7.

Charger Power Cord Receptacle

The 3-pin end of the charger power cord plugs into this receptacle.

Main Circuit Breaker(Reset Button)

When the voltage in your Travel Scooter's batteries becomes low or the Travel Scooter is heavily strained because of excessive loads or steep inclines,the main Circuit breaker may trip to protect the motor and electronics from damage.

III. YOUR TRAVEL SCOOTER

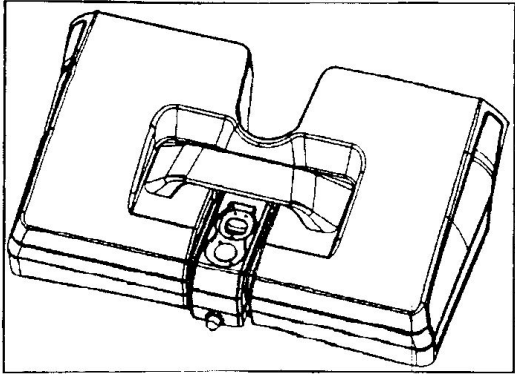

Figure 7. Battery Pack(20AHh Pack Shown

- The main circuit breaker reset button pops out when the breaker trips.
- When the breaker trips, the entire electrical system of your Travel Scooter shuts down.
- Allow a minute or two for your Travel Scooter's electronics to "rest".
- Push in the reset button to reset the main circuit breaker.
- If the main circuit breaker trips frequently, you may need to charge your batteries more often. you may also need to have your authorized provider perform a load test on your Travel Scooter's batteries.
- If the main circuit breaker trips repeatedly, see your authorized our provider for Service.

TILLER CONSOLE FUSE

The fuse located under the battery pack protects the tiller console electronics. See figure 8.

In the event any component of the tiller console is not responding, check this fuse, See VIII. " Basic Troubleshooting" for fuse replacement instructions.

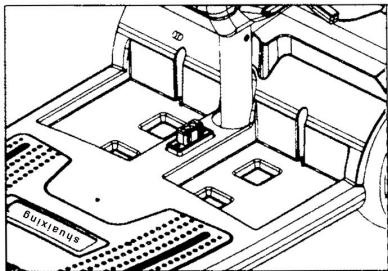

Figure 8.3-Amp Tiller Console Fuse

III. YOUR TRAVEL SCOOTER

OFF-BOARD BATTERY CHARGER

The off-board battery charger, when plugged into the charger power cord receptacle (located on the battery pack) and a standard electrical outlet, charges the Travel Scooter's batteries, See figure 9.

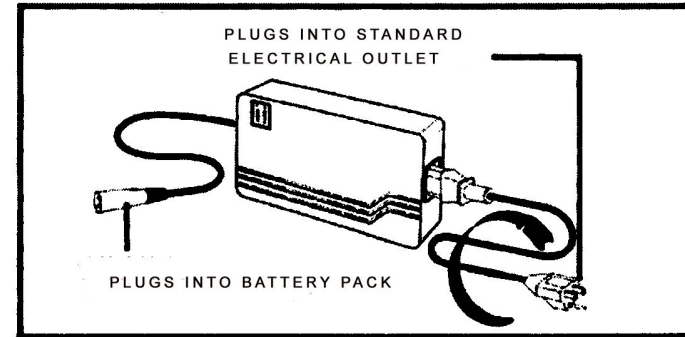

Figure 9. Off- Board Battery Charger

:

III. YOUR TRAVEL SCOOTER



READING YOUR BATTERY VOLTAGE

The battery condition meter on the tiller console indicates approximate strength of your batteries ,yellow a draining charge,and red indicates that an immediate recharge is necessary.See figure 12. To ensure the highest accuracy,the battery condition meter should be checked while operating your Travel Scooter at full speed on a dry, level surface.

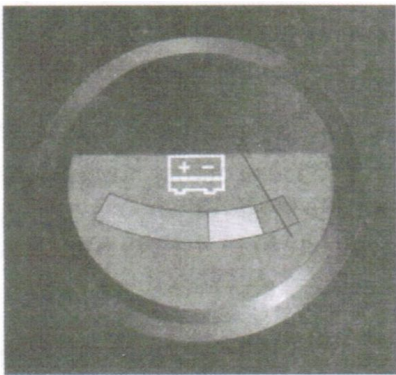

Figure 12. Battery Condition Meter

CHARGING YOUR BATTERIES

NOTE:The battery pack can be charged on or off the Travel Scooter.

IV.BATTERIES AND CHARGING



PROHIBITED!Removal of grounding prong can create electrical hazard.If necessary,properly install an approved 3-pronged adapter to an electrical outlet having 2-pronged plug access.



PROHIBITED!Never use an extension cord to plug in your battery charge directly into a properly wired standard electrical outle.



PROHIBITED! Do not allow unsupervised children to play near the Travel Scooter while the batteries are charging.we recommends That you do not charge the batteries while the Travel Scooter is occupied.



MANDATORY!Read the battery charging instructions in this Manual and in the manual supplied with the battery charger Before charging the batteries.



WARNING! Explosive gases may be generated while charging the batteries.Keep the Travel Scooter and battery charger away from Sources of ignition such as falmes or sparks and provide adequate ventilation when charging the batteries.

WARNING! You must recharge your Travel Scooter's with the supplied off-board charger.Do not use an automotive- type battery charger.



WARNING! Inspect the battery charger ,wiring,and connectors for damage for damage before each use .Contact your authorized provider if damage is found.

WARNING! Do not attempt to open the battery charger case.If the battery charger does not appear to be working correctly,contact your authorized provider,



WARNING!If the battery charger is equipped with cooling slots,then do not attempt to insert objects through these slots.

IV. BATTERIES AND CHARGING



WARNING! If your battery charger has not been tested and approved for outdoor use, then do not expose it to adverse of

extreme weather conditions. If the battery charger is exposed to adverse or extreme weather conditions, then it must be allowed to adjust to the difference in environmental conditions before use indoors. Refer to the manual supplied with the battery charger for more information.

Follow these easy steps to charge your batteries Safely:

1. Position your Travel Scooter or battery pack close to a standard electrical outlet. See figure 13.
2. Remove the key from the key switch.
3. Make certain that the manual freewheel lever is in the drive (rearward)
4. Plug the charger power cord into the charger power cord receptacle on your Travel Scooter, then into the electrical outlet. We recommend that you charge the batteries for 8 to 14 hours.

NOTE: The LED lights on the charger indicate different charger conditions at various times. Refer to the operating instructions supplied with the charger for a complete explanation of these indicators.

5. When the batteries are fully charged, unplug the charger power cord from the electrical outlet and then from the charger power cord receptacle.

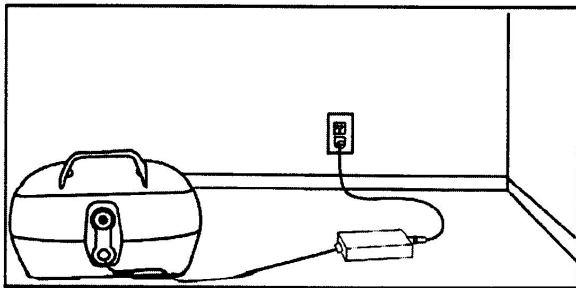

Figure 13. Charging The Batteries
(Battery Pack Removed)

NOTE: There is a charger inhibit function on your Travel Scooter. The Travel Scooter will not run and the battery condition

IV. BATTERIES AND CHARGING

meter will not operate while the batteries are charging (when pack is being charged on the Travel Scooter).

FREQUENTLY ASKED QUESTIONS

How does the charger work?

When your Travel Scooter's battery voltage is low, the charger works harder, sending more electrical current to the batteries to bring up their charge. As the batteries approach a full charge, the charger sends less and less electrical current. When the batteries are fully charged, the current sent from the charger is at nearly zero amperage. Therefore, when the charger is plugged in, it maintains the charge on your Travel Scooter's batteries, but does not overcharge them. We do not recommend that you charge your Travel Scooter's batteries for more than 24 consecutive hours.

What if my Travel Scooter's batteries will not charge?

- Ensure that the fuse on the battery pack is in working condition.
- Ensure both ends of the charger power cord are inserted fully.

Can I use a different charger?

Chargers are selected precisely for particular applications and are especially matched to the type, size and chemical formulation of specific batteries. For the safest and most efficient charging of your Travel Scooter's batteries, we recommend use of the charger supplied as original equipment with your scooter product only. Any charging method resulting in batteries being charged individually is especially prohibited.

How often must I charge the batteries?

Two major factors must be considered when deciding how often to charge your Travel Scooter's batteries:

- All day use on a daily basis.
- Infrequent or sporadic use.

With these considerations in mind, you can determine how often and for how long you should charge your Travel Scooter's batteries. The battery charger was designed so that it will not overcharge your Travel Scooter's batteries.

However, you may encounter some problems if you do not charge your batteries

IV. BATTERIES AND CHARGING

often enough and if you do not charge them on a regular basis. Following the guidelines below will provide safe and reliable battery operation and charging.

- If you use your Travel Scooter daily, charge its batteries as soon as you finish using it for the day, Your Travel Scooter will be ready each morning. We recommend that you charge your Travel Scooter's batteries for 8 to 14 hours after Daily use.

- If you use your Travel Scooter once a week or less, charge its batteries at least once a week for 12 to 14 hours at time.

- Keep your Travel Scooter's batteries fully charged.

- Avoid deeply discharging your Travel Scooter's batteries.

How can I ensure maximum battery life?

Fully charged deep-cycle batteries provide reliable performance and extended battery life. Keep your Travel Scooter's batteries fully charged whenever possible. Protect your Travel Scooter and batteries from extreme heat or cold. Batteries that are regularly and deeply discharged, infrequently charged, stored in extreme temperatures, or stored without a full charge may be permanently damaged, causing unreliable performance and limited service life.

How can I get maximum range or distance per charge?

Rarely will you have ideal driving conditions ---smooth, flat hard driving surfaces with no wind or curves. Often, you will face hills, pavement cracks, uneven and loosely packed surfaces, curves, and wind, all of which affect the distance of running time per battery charge. Below are a few suggestions for obtaining the maximum range per battery charge.

- Always fully charge your Travel Scooter's batteries prior to daily use.

- Limit your baggage weight to essential items.

- Try to maintain an even speed while your Travel Scooter is in motion.

- Avoid stop-and-go driving.

IV. BATTERIES AND CHARGING



WARNING! Corrosive chemicals are contained in batteries. Use only AGM or Gel-Cell batteries to reduce the risk of

Leakage or explosive conditions.

NOTE: Sealed batteries are not serviceable. Do not remove the caps.

How do I change a battery in my Travel Scooter?



MANDATORY! Battery posts, terminals, and related accessories contain lead compounds.

Wear goggles and gloves when handling batteries and wash hands handling

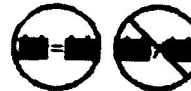

WARNING! Always use two batteries of the exact same type, chemistry, and amp-hour (Ah) capacity. Refer to the

Specifications table in this manual and in the manual supplied with the battery charger for recommended type and capacities.



WARNING! Do not mix old and new batteries. Always replace both batteries at the same time

WARNING! Contact your Provider if you have any questions regarding the batteries in your Travel Scooter.

WARNING! Do not replace the batteries while the Travel Scooter is occupied

WARNING! The batteries on your Travel Scooter should only be serviced or Replaced by an authorized provider or a qualified technician.

1. Remove the battery pack from the Travel Scooter.
2. Carefully turn the pack upside down.
3. Remove the eight (8) screws from the perimeter of the battery pack.
4. Carefully turn the pack right side up and remove the lid.
5. Disconnect the black (-) and red (+) battery cables from the battery terminals of each of the batteries. See figure 14.
6. Remove the old batteries.
7. Place the new batteries into the battery pack.
8. Connect the red battery cable to the positive (+) battery terminal of each battery.

IV. BATTERIES AND CHARGING

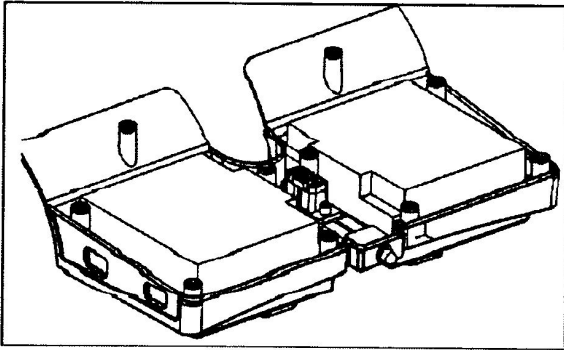

Figure 14. Battery replacement.

9. Connect the black battery cable to the negative(-) battery terminal of each battery.
10. Position the lid back onto the battery pack ensuring all wires are inside the pack so they don't become pinched.
11. Carefully turn the pack upside down.
12. Reinstall all screws and tighten.

NOTE: 17Ah batteries require the removal of a nut and bolt when disconnecting the battery cable from the battery terminal.

NOTE: If you encounter a damaged or cracked battery, immediately enclose it in a Plastic bag and contact your local waste disposal agency or authorized Provider for instructions on disposal and battery recycling which is our recommended course of action.

Why do my new batteries seem weak?

Deep-cycle batteries employ a different chemical technology than that used in car batteries, nickel-cadmium batteries (Nics), and other common battery types. Deep-Cycle batteries are specifically designed to provide power, drain down their charge, and then accept a relatively quick recharge (8 to 14 hours).

We work closely with your battery manufacturer to provide batteries that best suit your Travel Scooter's specific electrical demands. Fresh batteries are shipped fully charged to our customers. During shipping, the batteries may encounter temperature extremes that can influence their initial performance. Heat diminishes the charge on the battery; cold slows the available power and extends the time needed to recharge the battery.

IV. BATTERIES AND CHARGING

It may take a few days for the temperature of your Travel Scooter's batteries to stabilize and adjust to their new room or ambient temperature. More importantly, it takes a few charging cycles (partial draining followed by full recharging) to establish the critical chemical balance that is essential to a deep-cycle battery's peak performance and long life.

Follow these steps to properly break in your Travel Scooter's new batteries for maximum efficiency and service life.

1. Fully recharge any new battery prior to its initial use. This charging cycle brings the battery up to about 88% of its peak performance level.
2. Operate your new Travel Scooter in familiar and safe areas. Drive slowly at first and do not travel too far from your home or familiar surroundings until you have become accustomed to your Travel Scooter's controls and have properly broken in your Travel Scooter's batteries.
3. Fully recharge the batteries. They should be at over 90% of their peak performance level.
4. Operate your Travel Scooter again.
5. Fully recharge the batteries again.
6. After four or five charging cycles, the batteries are able to receive a charge of 100% of their peak performance level and are able to last for an extended period of time.

What about public transportation?

If you intend to use public transportation with your Travel Scooter, you must contact the transportation provider in advance to determine their specific requirements.

V. OPERATION

BEFORE GETTING ONTO YOUR TRAVEL SCOOTER

- Have you fully charged the batteries? See IV. "Batteries and Charging"
- Is the manual freewheel lever in the drive (rearward) position? Never leave the manual freewheel lever in the forward position unless you are manually pushing your Travel Scooter.
- Ensure the tiller lock knob is in the unlocked position. See VII. "Disassembly and Assembly".

V.OPERATION

GETTING ONTO YOUR TRAVEL SCOOTER.

1.Make certain that the key is removed from the key switch.



WARNING!Never attempt to get onto or off of your Travel Scooter without first removing the key from the key switch.

This will prevent the Travel Scooter from moving if accidental throttle control lever contact is made.

2.Stand at the side of your Travel Scooter.

3.Disengage the seat rotation lever and rotate the seat until it is facing you .

4.Make certain that the seat is secured into position.

5. Position yourself comfortably and securely in the seat.

6.Disengage the seat rotation lever and rotate the seat until you are facing forward

7.Make certain that the seat is secured into position.

8.Make certain that your feet are safely on the floorboard.

PRE-RIDE ADJUSTMENTS AND CHECKS

■ Is the seat at the proper height? See VI.” Comfort Adjustments”

■ Is the seat secured into place?

■ Is the tiller at a comfortable setting and secured into place ?See VI.” Comfort Adjustments”

■ Is the key fully inserted into the key switch and turned clockwise to the “on” position?

■ Does the Travel Scooter’s horn work properly?

■ Is your proposed path clear of people ,pets and obstacles?

■ Have you planned your route to avoid adverse terrain and as many inclines as Possible?

OPERATING YOUR TRAVEL SCOOTER



WARNING!The following can adversely affect steering and Stability While operating your Travel Scooter

■ **Holding onto or attaching a leash to walk your pet.**

■ **Carrying passengers(including pets)**

■ **Hanging any article from the tiller.**

V.OPERATION

■ **Towing or being pushed by another motorized vehicle. Such practices could cause loss of control and / or tipping ,resulting in personal injury.**

Keep both hands on the tiller and your feet on the floorboard at all times while operating your Travel Scooter.This driving position gives you the most control over your vehicle.

■ Set the speed adjustment dial to your desired speed.

■ Press your thumb against the appropriate side of the throttle control lever.

■The electromechanical disc park brake automatically disengages and the Travel IScooter accelerates smoothly to be speed you preselected with the speed adjustment dial.

■ Pull on the left handgrip to steer your Travel Scooter to the left.

■ Pull on the right handtrip to steer your Travel Scooter to the right.

■ Move the tiller to the center position to drive straight ahead.

■ To stop, slowly release the trottle control lever. The electronic brakes will automatically engage yoiur Travel Scooter comes to a stop.

NOTE:Your Travel Scooter’s reverse speed is slower than that of the forward speed you preset with the speed adjustment dial.

GETTING OFF OF YOUR TRAVEL SCOOTER

1.Bring your Travel Scooter to a complete stop.

2.Remove the key from the key switch.

3.Disengage the seat rotation lever and rotate the seat until you are facing toward the side of your Travel Scooter.

4.Make certain that the seat is secured into position.

5.Carefully and safely get out fo the seat and stand of the side of your Travel Scooter.

6.You can leave the seat facing to the side to facilitate boarding your Travel Scooter next time.

POWER DOWN TIMER FEATURE

Your Travel Scooter is equipped with an energy saving automatic power down timer feature designed to preserve yoiur Travel Scooter’s battery life.If you mistakenly leave the key in the key switch and in the “on “position but do not use your Travel Scooter for approximately 20 minutes,the Travel Scooter’s controller

V. OPERATION

Shuts down automatically. If the power down timer feature takes effect, perform the following steps to resume normal operation.

1. Remove the key from the key switch.
2. Reinsert the key and power up your Travel Scooter.

VI COMFORT ADJUSTMENTS

TILLER ANGLE ADJUSTMENT



WARNING! Remove the key from the key switch before adjusting the tiller or the seat. Never attempt to adjust the tiller or the seat

While the Travel Scooter is in motion.

Your Travel Scooter is equipped with an adjustable pivoting tiller.

1. While supporting the tiller, turn the tiller adjustment knob counterclockwise to loosen the tiller. See **figure 15**.
2. Move the tiller to a comfortable position.
3. Turn the tiller adjustment knob clockwise to secure the tiller in position.

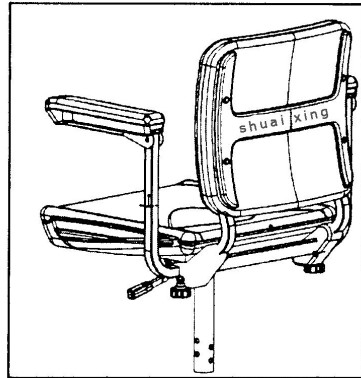
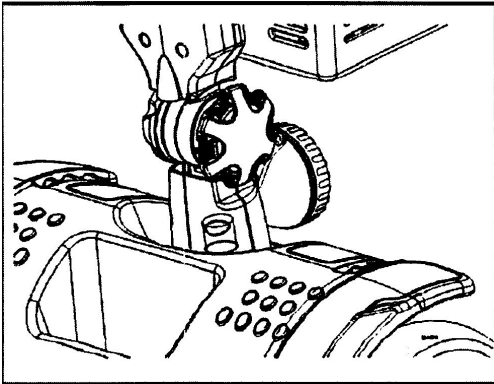

Figure 15. Tiller Adjustment Knob.

Figure 16. Seat

NOTE: In order to fully lower the tiller, you must first remove the seat and battery pack. Remove the seat by pulling it straight up and off the Travel Scooter.

SEAT ROTATION ADJUSTMENT

The seat rotation lever, located on the right side of the seat

VI COMFORT ADJUSTMENTS

base, secures the seat into several positions.

1. Pull up on the seat rotation lever to disengage the seat.
2. Rotate the seat to the desired position.
3. Release the lever to secure the seat into place

ARMREST WIDTH ADJUSTMENT

The armrest width can be adjusted inward or outward

1. Loosen the armrest adjustment knobs. See figure 16.
2. Use the attached ring to pull and remove the detent pins.
3. Slide the armrests in or out to the desired width.
4. Align the adjustment holes on the seat frame and armrest, then reinsert the detent pins.
5. Tighten the armrest adjustment knobs.

NOTE: Pivot the armrests upward to aid in getting onto and off of your Travel Scooter.

Seat HEIGHT ADJUSTMENT

The seat can be repositioned to different heights. See figure 17.

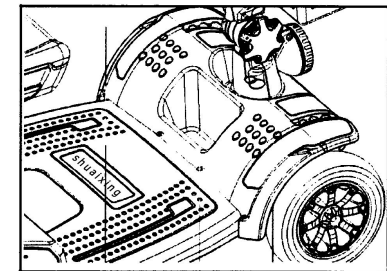
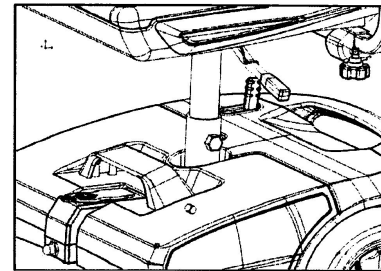

Figure 17. Seat Height Adjustment **Figure 18. Front Storage Area.**

1. Remove the seat and battery pack from your Travel Scooter.
2. Use the attached ring to pull and remove the detent pin from the lower seat post.
3. Raise or lower the upper seat post to the desired seat height.
4. While holding the upper seat post at that height, align the adjustment holes of the upper and lower seat post.
5. Fully insert the detent pin
6. Replace the battery pack and seat.

VI COMFORT ADJUSTMENTS

FRONT STORAGE AREA

Your Travel Scooter is equipped with a front storage area that can be removed if additional leg or foot room is needed. See figure 18. Remove the screws to separate the small basket from the Travel Scooter.

NOTE:As a precaution, avoid placing wallets, keys, or Valuable items in the storage area.

VII.DISASSEMBLY AND ASSEMBLY

DISASSEMBLY

You can disassemble the Travel Scooter into four pieces:the seat the frame ,the basket, and the battery pack.See figure 19.

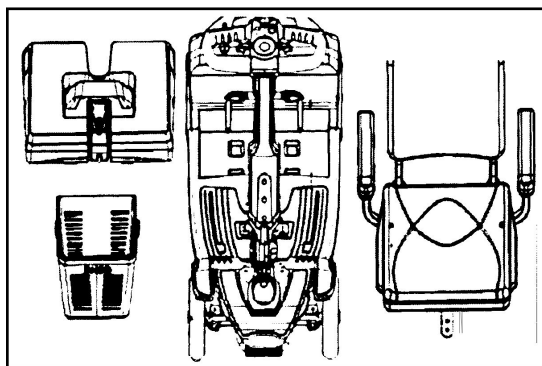

Figure 19.Disassembled Travel

No tools are required to disassemble or assemble your Travel Scooter. Always disassemble or assemble your Travel Scooter on a level, dry surface with sufficient room for you to work and move around--about five feet(1.5 meters) in all directions Remember that some Travel Scooter components are heavy and you may need assistance when lifting them.

No tools are required to disassemble or assemble your Travel Scooter. Always disassemble or assemble your Travel Scooter on a level, dry surface with sufficient room for you to work and move around--about five feet(1.5 meters) in all directions Remember that some Travel Scooter components are heavy and you may need assistance when lifting them.

VII.DISASSEMBLY AND ASSEMBLY



WARNING!Do not lift weight beyond your physical capability . Ask for assistance when necessary while disassembling or

Assembling your Travel Scooter.

- 1.Remove the seat by lifting it straight up and off of the Travel Scooter.If you encounter resistance when removing the seat,disengage the seat rotation lever and swivel the seat back and forth while lifting up on the seat.
- 2.Remove the battery pack from the Travel Scooter.

Frame Separation

- 1.Lower the tiller and tighten the taller adjustment knob.

ASSEMBLY

- 1.Raise the tiller and fully tighten the tiller adjustment knob.
- 2.Reinstall the battery-pack.
- 3.Reinstall the seat and rotate it until it is secured into place.

VIII. BASIC TROUBLESHOOTING.

Any electromechanical device occasionally requires some trouble-shooting. However,most of the problems that may arise can usually be solved with a bit of Thought and common sense .Many of these problems occur because the batteries are not fully charged or because the batteries are worn down and can no longer hold a charge.

DIAGNOSTIC BEEP CODES

The diagnostic beep codes for your Travel Scooter are designed to help you perform basic troubleshooting quickly and easily .A diagnostic beep code will sound in the event one of the conditions listed below develops.

NOTE:Your Travel Scooter will not run unless the beep code condition is resolved And the Travel Scooter has been turned off then turned back on .

What if all the systems on my Travel Scooter seem to “dead”?

- Make certain that the key is in the “ on “ position.
- Check that the batteries are fully charged .
- Push in the main circuit breaker reset button.See III.”Your Travel Scooter.”
- Be sure the power down timer feature has not been activated

VIII. BASIC TROUBLESHOOTING.

See V."Operation"

- Check the tiller scooter console fuse located under the battery pack.

To check a fuse:

- 1.Remove the fuse by pulling it out of its slot.
- 2.Examine the fuse to be sure it is blown .See figures 20 and 21
- 3.Inset a new fuse of the proper rating .

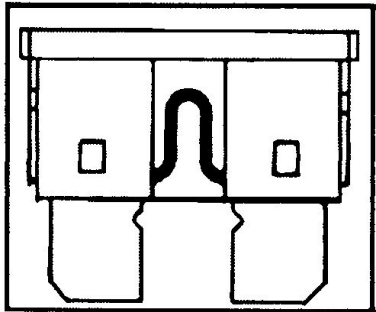

figures 20. Working fuse

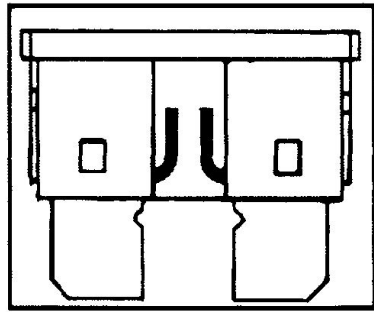

figures 21.blown fuse



WARNING! The replacement fuse must exactly match the rating of the old fuse .Failure to use properly rated fuses may cause

Damage to the electrical system

What if the travel scooter's batteries won't charge?

- Check the fuse located on the battery pack.Replace if necessary.
- During the charging process,if the charger LED's never ndicate a full charge, Check the fuse located on the battery pack ,Replace if necessary.
- Ensure bothends of the charger power cord are inserted fully.
- If the battery pack fuse continually blows ,contact your authorized our provider for service.

What if the Travel Scooter does not move when I press the throttle control lever?

- When the manual freewheel lever is pushed forward ,the brakes are disengaged and all power to the motor/transaxle assembly is cut.
- Pull back on the manual freewheel lever,turn the travel scooter off ,and then

VIII. BASIC TROUBLESHOOTING

back on to return to normal operation.

What if the main circuit breaker repeatedly trips?

- If the main circuit breaker trips repeatedly,see your authorized for service
- Charge the travel scooter's batteries more frequently .See IV."Batteries and Charging".
- If the prople continues,have both of your travel scooter's batteries load tested by your authorized provider
- You may also perform the load test yourself.Battery load testers are avaiilabel at most automovtive parts stores.
- Follow the directions supplied with the load tester.
- See IV."Batteries and Charging" or "Appendix I-specifications" for information about your travel sooceter's battery type.

What if the battery condition meter dips way down and the motor surges or hesitates when I press the throttle control lever?

- Fully charge your travel scooter's batteries.See IV."Batteries and Charging".
- Have youir authorized provider load test each battery.
- Or,see the previous troubleshooting question for load testing the batteries yourself.If you experience any problems with your travel scooter that you are not able to solve ,immediately contact your authorized provider for information Maintenance and service.

IX.CARE AND MAINTENANCE

Your Travel Scooter requires a minimal amount of care and maintenance.If you do not feel confident in your ability to perform the maintenance listed below,you may schedule inspection and maintenance at your Regularly inspect your travel Scooter's tires for signs of wear.

EXTERIOR SURFACES

Bumpers,tires and trim can benefit from an occasional applicanton of a rubber or vinly conditioner.



WARNING!Do not use a rubber or vinyl conditioner on the Travel Scooter's vinyl seat or tire tread,as they will become

VIII. BASIC TROUBLESHOOTING

■ ■ (2)	Battery voltage is too low to operate the Travel Scooter	Charge fully until charger and any meters indicate completion
■ ■ ■ (3)	Battery voltage is too high to operate the Travel Scooter	Contact your authorized provider for assistance.
■ ■ ■ ■ ■ (5)	Solenoid brake trip. The manual freewheel lever may be in the freewheel position.	Remove the key then push the manual freewheel lever to the drive position, restart your Travel Scooter.
■ ■ ■ ■ ■ ■ (6)	Throttle trip. The throttle control lever may have been depressed while inserting the key	Release the throttle control lever completely. then reinsert the key.
■ ■ ■ ■ ■ ■ ■ (7)	Throttle trip. The throttle control lever may have been depressed while inserting the key	Contact your authorized provider for assistance.
■ ■ ■ ■ ■ ■ ■ ■ (8)	The Travel Scooter 's motor is disconnected	Contact your authorized provider for assistance.
■ ■ ■ ■ ■ ■ ■ ■ ■ (9)	Possible controller trip. You may be attempting to install the battery pack while the key is inserted or the motor controller may be in over heat protective mode	Shut down your Travel Scooter for a minimum of several minutes to allow the controller to cool. or try reinserting the key into the key switch.

IX. CARE AND MAINTENANCE

Dangerously slippery.

CLEANING AND DISINFECTION

Use damp cloth and mild ,non-abrasive cleanser to clean the plastic and metal parts of your Travel Scooter. Avoid using products that may scratch the surface of your Travel Scooter.

If necessary, clean your product with an approved disinfectant. Make sure the disinfectant is safe for use on your product before application.



WARNING! Follow all safety instructions for the proper use of the disinfectant and /or cleaning agent before applying it to your

product. Failure to comply may result in skin irritation or premature deterioration of upholstery and /or Travel Scooter finishes.

BATTERY TERMINAL CONNECTIONS

Make certain that the terminal connections remain tight and are not corroded.

WIRING HARNESSSES

Regularly check all wiring connections .

Regularly check all wiring insulation, including the charger power cord, for wear or damage.

Have your authorized provider repair or replace any damaged connector, connection or insulation that you find before using your Travel Scooter again.



PROHIBITEND! Even though the Travel Scooter has passed the necessary testing requirements for ingress of liquids, you should

Keep electrical connections away from sources of dampness ,including direct exposure to water or bodily fluids and incontinence. Check electrical Components frequently for signs of corrosion and replace as necessary.

ABS PLASTIC SHROUDS

The shroud pieces are formed from durable ABS plastic and are coated with an advanced formula urethane paint . A light application of car wax will help the shrouds retain their high gloss.

AXLE BEARINGS AND THE MOTOR /TRANSAXLE ASSEMBLY

These items are all prelubricated, sealed and require no subsequent lubrications

IX.CARE AND MAINTENANCE

MOTOR BRUSHES

The motor brushes are housed inside of the motor/transaxle assembly.They should be inspected periodically for wear by your authorized provider.

CONSOLE ,CHARGER AND REAR ELECTRONICS

Keep these areas free of moisture.

Allow these areas to dry thoroughly if they have been exposed to moisture before operating your Travel Scooter again.

NYLON LOCK NUT REPLACEMENT

Any nylon insert lock nut removed during the periodic maintenance,assembly or disassembly of the Travel Scooter must be replaced with a new nut.Nylon insert lock nuts should not be reused as it may cause damage to the nylon insert, resulting in a less secure fit .Replacement nylon insert lock nuts are available at local hardware stores or through your authorized our provider.

STORING YOIUR TRAVEL SCOOTER

If youi plan on not using your travel scooter for an extended period of time ,it is best to :

1. Fully charge its batteries prior to storage.
- 2.Remove the battery pack from the travel scooter.
- 3.Store your Travel Scooter in a warm ,dry environment.
- 4.Avoid storing your travel scooter where it will be exposed to temperature extremes.

Batteries that are regularly and deeply discharged,infrequently charged stored in extreme temperatures or stored without a full charge may be permanently damaged ,causing unreliable performance and limited service life .It is recommend that you charge the Travel Scooter batteries periodically throughout periods of prolonged storage to ensure proper performance.



WARNNG! Always protect batteries from freezing temperatures and never charge a frozen battery.

For prolonged storage, you may wish to place several boards under the frame of your Travel Scooter to raise it off of the ground .This takes the weight off the tires and reduces the possibility of flat spots developing on the areas of the tires contacting the ground.

IX.CARE AND MAINTENANCE

DISPOSAL OF YOUR SCOOTER

Your Travel Scooter must be disposed of according to applicable local and national statutory regulations. Contact your local waste disposal agency or your authorized provider for information on proper disposal of packaging ,metal frame Components,plastic components,electronics ,and batteries.

x.WARRANTY

FIVE-YEAR LIMITED WARRANTY

For five years from the date of purchase,We will repair or replace at our option to the original purchaser any of the following parts found upon examination by an authorized representative of us to be defective in material and /or workmanship:

Structural frame components ,including:

■ Platform ■ fork ■ seat post ■ frame welds

TWO-YEAR LIMITED WARRANTY

All electronic parts,including controllers and battery cahrges ,have two(2) year warranty .Servicing to the controller or battery chager must be carried out by your authorized provider.Any attempt to open or dismantle these items renders the guarantee void on that item.

ONE-YEAR LIMITED WARRANTY

For one year from the date of purchase ,We will repair or replace at our option to the original purchaser any of the following parts found upon examination by an authorized representavie of us to be defective in material and /or workmanship:

Drivetrain including:

■ differential ■ motor ■ brake

SIX-MONTH WARRANTY

The batteries are covered by a separate six(6)month warranty,provided by the battery manufacturer.Gradual deterioration in performance due to being left in a discharged state,left in cold conditions for long perods of time or worm out thourgh heavy use is not covered .

RECONDITIONED UNITS WARRANTY

All reconditioned unites are covered by a six month warrant from us effective from the date of purchase.

x.WARRANTY

WARRANTY EXCLUSIONS

This warranty does not extend to those items which may require replacement due to normal wear tear .

- ABS plastic shrouds ■ Tires and bulbs ■ Upholstery and seating.
- Circumstances beyond the control of us.
- Labor ,service calls ,shipping ,and other charges incurred of the product ,unless specifically authorized,in advance ,by our mobility products corporation.
- Repairs and /or modifications made to any part of the travel Scooter without specific and prior consent from us.

EXCLUSIONS ALSO INCLUDE COMPONENTS WITH DAMAGE CASUED BY:

- Contamination
- Abuse ,misuse , accident or negligence .
- Battery fluid spillage or leakage
- Commercial use or use than normal
- Improper operation,maintenance ,or storage
- Batteries not properly maintained by recommended charging and storage procedures

There is no other express warranty.

Implied warranties ,including those of merchantability and fitness for a particular purpose ,are limited to one year from the date of original purchase and to the extent permitted by law. Any and all implied warranties are excluded. This is exclusive remedy. Liabilities for consequential damages under any and all warranties are excluded.

Some states do not allow limitations on how long an implied warranty lasts or do not allow the exclusion of limitation of incidental or consequential damages .So , the above limitation or exclusion or exclusion may not apply to you .

APPENDIXI- SPECIFICATION

Model Numbers	Blimo X-40
Maximum safe slope	See figure 1.
Maximum climbing ability	See figure1.
Maximum obstacle climbing ability	2 in(5cm)
Colors	Red,blud,silve(interchangeable panels)
Overall length ²	110 cm
Overrall width ²	51 cm)
Total weight without batteries	41.2 kg
Heaviest piece when disassembled (front section)	29.2kg
Turning radius ²	125cm
Speed (maximum) ¹	Variable up to 7.8km/h
Range per charge ^{1,5}	(with 20Ah batteries) up to 28km
Ground clearance ²	8.2 cm at mid -frame
Weight capacity	120 KG
Standard seating	Type:foldable
Drive system	Rear-wheel drive,sealed transaxle,24 volt DC motor ,250W,
Dual Braking System	Electronic, regenerative,and electromechanical
Tires ³	Type:solid Size: 22 cm
Battery	24V 20Ah Lithium (480Wh)
Battery pack weight	20Ah: 4.3kg
Battery Charger	Off -board charger